

Senator WSS 8 KG 1400RPM

User Manual

IFB
www.ifbappliances.com



Read instructions before switching on the washing machine. Observe safety guidelines for installation.

Welcome to the IFB family.

India's best fully automatic washing machine is now at your service.
Here's to your freedom!

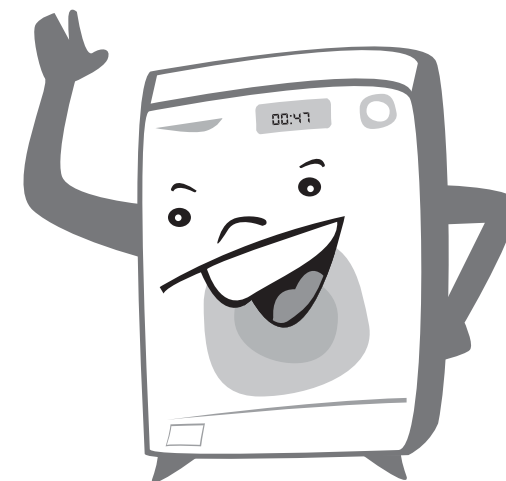

Senator WSS 8 KG 1400RPM

The A to Z of your washing machine

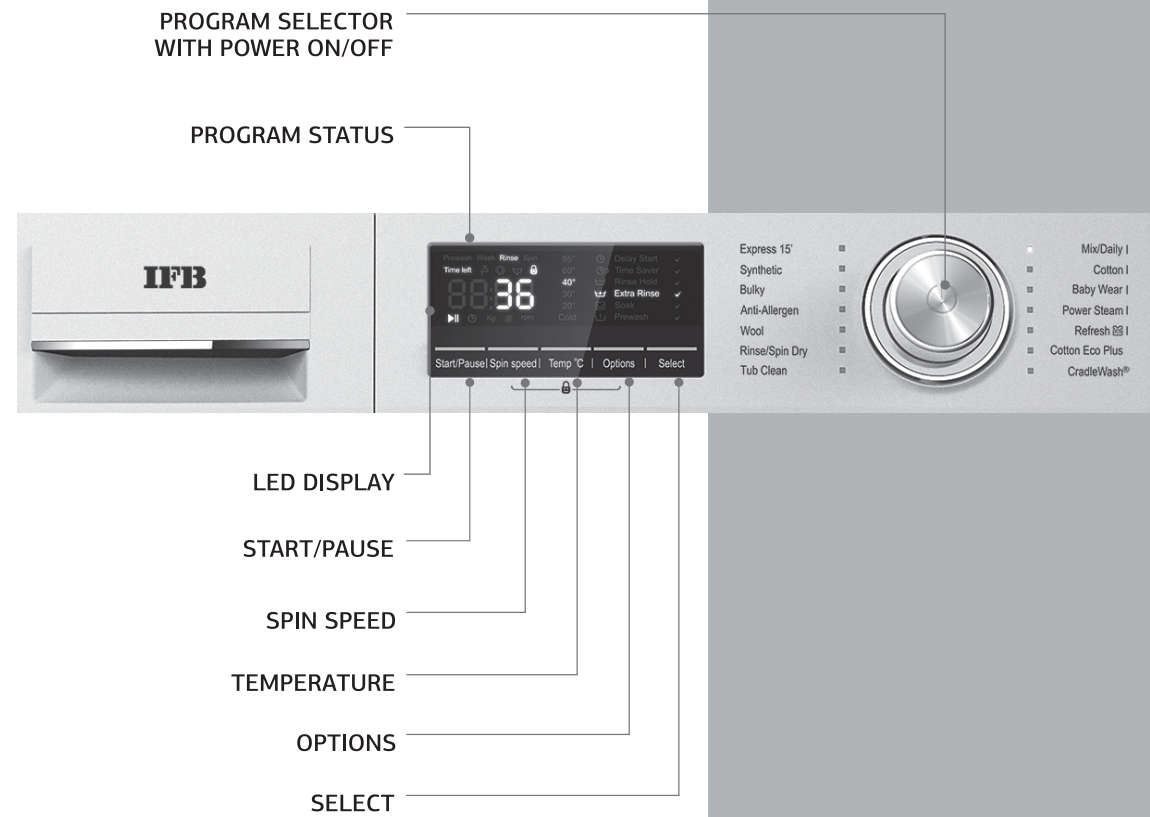

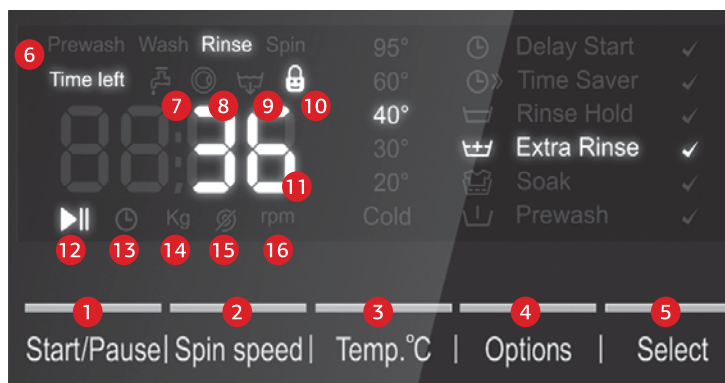

Display Descriptions

- 1 Start/Pause: To start or pause the machine or program. Glows when the program is running and flashes during Pause mode.
- 2 Spin: To select the different spin speeds available.
- 3 Temperature. Button to select the different temperatures available. Glows when selected, flashes if available and remains OFF if not selected.
- 4 Options: Button to select the different options available corresponding to the program. The corresponding option will glow when selected, flash if available for selection and remain OFF if not selectable.
- 5 Select: To select the options available.

- 6 Status Bar: Glows indicating present status of the wash process.
- 7 Tap: Glows during water intake in wash process
- 8 Door: Shows door status. Glows when door is open, flashes during door unlocking, remains OFF when door is locked.
- 9 Drain: Glows during draining of water in wash process.
- 10 Child Lock: Glows when Child Lock is selected, flashes to indicate deselection.
- 11 Time Status: Displays program time, spin speed, temperature, error codes and other status.
- 12 Start/Pause: Glows when program is running, flashes during Pause mode.
- 13 Delay: Will glow during selection of Delay Start and during Delay Start process, if selected.
- 14 Kg: Will glow indicating the maximum capacity of the program in Kg
- 15 Spin Cancel: Symbol glows if selected.
- 16 RPM: Will glow during selection of spin speed.



Safety guidelines for installation

- Keep the packaging material. It may come in handy when shifting residence.
- Old hoses must not be reused. Always use the new hoses delivered with the machine.
- Before cleaning the machine, ensure you disconnect the main electricity supply and take the plug off the socket.
- Not removing all the packaging and transit bolts before using the appliance may lead to serious damage. Please do not operate the machine until the transit bolts have been removed.
- All washing machine installation work must be carried out only by authorised IFB Care Service Personnel.
- Pre-installation work such as plumbing and electrical connections must be carried out by a qualified fitter, electrician or technician.
- Do not operate the appliance where inflammable substances such as oil, benzene or highly inflammable gas are present. Such materials may cause fire or explosions. Never use combustible detergents.
- Do not install your washing machine in rooms where temperatures below freezing may occur. Frozen hoses may burst under pressure. The reliability of the electronic control unit may be impaired at temperatures below freezing point and above 50 °C.
- Install the machine in a room with adequate ventilation. Avoid a room with no windows. The back of the machine should be at least 4 inches (100 mm) away from the wall.
- The machine is provided with ventilating openings on the base. Always put the machine on the floor after removing the carpet.
- Do not install the machine in a damp area or bathroom with exposure to a direct shower.
- Protect the machine from direct sunlight and rainfall.



- Do not place the machine on a slanting, uneven or unstable surface.
- A concrete floor is the most suitable installation surface for a washing machine, being far less prone to vibration during the spin cycle than wooden floorboards.
- The washing machine is not suitable for connection to a hot water supply.
- The machine is designed to operate with water flow pressure between 0.3 Bar–10 Bar. Lower water pressure can lead to malfunction of your machine.



Safety instructions

Read all instructions and explanations for installation carefully before use.
Follow the instructions carefully. Keep the operating instructions handy for later use.

Any damage, which may be caused by cockroaches or other vermin, will not be covered by the appliance guarantee.

- Do not install and use a damaged machine. Before connecting the machine, ensure that the connection data on the data plate (fusing, voltage and frequency) match the main electricity supply. If in any doubt, consult IFB Care.
- Do not wash or dry articles that have been cleaned, washed, soaked in or dabbed with combustible or explosive substances (such as oil, paint, gasoline, degreasers, dry cleaning solvents, kerosene etc). This may result in fire or explosions.
- Before using the machine for the first time, check that the transit bolt at the rear of the machine has been removed (see section on installation).
- Turn OFF the stopcock if the machine is to be left for any length of time (eg holiday) especially if there is no floor drain (gully) in the immediate vicinity.
- This appliance can be used by children aged 8 years and above and persons with reduced physical, sensory or mental capabilities or lack of experience and knowledge if they have been given supervision or instructions concerning the use of the appliance in a safe way and understand the hazards involved.
- Children should not play with the appliance.
- Cleaning and user maintenance should not be performed by children without supervision.



Caution

- The electrical safety of this appliance can only be guaranteed when continuity is complete between the machine and an effective earthing system, which complies with local and national regulations. It is most important that a qualified electrician regularly tests this basic safety requirement. The manufacturer cannot be held responsible for the consequences of an inadequate earthing system.
- For safety reasons do not operate this appliance on an extension cable. Extension leads do not guarantee the required safety of the appliance.
- There is danger of overheating.
- The machine is built in accordance with current safety requirements.
- Unauthorised repairs could result in unforeseen dangers for the user, for which the manufacturer cannot accept responsibility. Only authorised IFB Care Service Personnel should undertake repairs.
- The machine is completely isolated from the electricity supply only when it is switched OFF at the wall socket and the plug is taken out, or it is switched OFF from the main source, or the main fuse is taken out or MCB switched OFF.
- This machine must only be connected to the onsite water supply using a new hose kit. Old hoses must not be reused. Only genuine IFB original spare parts should replace faulty components. Only when these parts are fitted can the safety standards of the machine be guaranteed.
- If the connection cable is faulty, it must be replaced only by an IFB approved service technician to protect the user from danger.
- A washer and dryer should never be stacked without using the proper stacking kit. Doing so is extremely dangerous, as the dryer may vibrate off the washing machine during use.



About eWaste

eWaste or Electronic Waste or Waste Electrical and Electronic Equipment (WEEE) are the terms used to describe old, end-of-life or discarded appliances using electricity.

Dos

- Always dispose of products that have reached end-of-life by calling an authorised local eWaste recycler.
- Always drop off used electronic products, batteries or accessories at your nearest authorised eWaste recycler when they reach end-of-life.
- Whenever possible, or as instructed, sort packaging materials according to responsible waste disposal and recycling options.

Don'ts

- Do not dismantle electronic products on your own.
- Do not throw electronic products in bins with a 'Do Not Dispose' sign.
- Do not give eWaste to informal and unorganised sectors such as local scrap dealers and rag pickers.
- Do not dispose of your product in garbage bins along with municipal waste that ultimately reaches landfills.

- Do not pull the cord to disconnect the plug. Hold the plug itself. Do not insert or remove the plug with damp hands.
- Do not drag the washing machine if it contains the wash load or when in operation.
- Do not move the washing machine if it contains the wash load or when in operation.
- Do not spill water over the machine. In case of spillage, wipe dry. Avoid the machine coming in contact with floor cleaning chemicals.
- Do not wash or spray water over the switch or control panel.
- Do not wash shoes or utensils in the machine.
- Use detergent recommended for the washing machine.
- Keep your machine dry to avoid corrosion/rusting. Take special care to wipe the machine after cleaning coin trap.
- Check the labels on garments for the determining conditions under which fabrics are to be washed.
- The machine is tested with water during assembly for performance checking. Condensed droplets of water may remain inside the drum. It is advisable to run the machine without a wash load in the Cotton maximum temperature program with detergent for the first time after installation.
- Ensure that the machine is connected to a 3 pin socket with good earthing and 16 Amp MCB or other automatic short circuit protection devices.
- Textiles that have been pre-treated in solvent based cleaning agents must be thoroughly rinsed in clean water before being washed in the machine.
- Never use solvent based cleaning agents in this machine, as this may result in damage to component parts and create toxic fumes. Such detergents also pose a threat of fire and explosion hazards.

Risks of Improper Handling of eWaste

eWaste usually includes components which, if disposed of improperly, hold environmental consequences such as air, water and soil pollution and also pose risks to human health.

By ensuring this product is disposed of correctly, you will

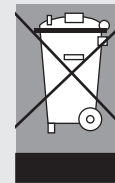

help prevent potential negative consequences for the environment and human health. Components and materials used in

the manufacture of this washing machine are fully compliant with provisions of hazardous substances outlined in eWaste Management Rules, 2016.

For Detailed Information and Disposal Request

Contact IFB Care at 1860 425 5678/1860 208 5678 and provide your details to our representative to request your product to be picked up for disposal.



- Only use dyes specified by the manufacturer as being suitable for use in a domestic washing machine. Always read the manufacturer's instructions carefully.
- Colour runs and dye removers contain sulphur compounds, which can cause damage such as corrosion. Do not use these products in this machine.
- For machines with a porthole door, remember that the porthole glass will be hot when washing at very high temperatures. Do not let children touch it.
- Always make sure that the drum is stationary before removing clothes. Reaching into a moving drum is extremely dangerous.

Flooding danger

- While hooking the drain hose into a wash basin, check that the water drains OFF quickly to prevent the sink from overflowing. Make sure the drain hose is secure so that the force of the water flowing out of the hose does not dislodge it. Otherwise, this will result in flooding.
- Take care to ensure that foreign objects (eg nails, pins, coins, paper clips etc) do not find their way into the machine with the washing. These may damage components of the machine (eg suds container, drum etc), which in turn can result in damage to the washing.

Contents

	PAGE
• Safety guidelines	06
• Safety instructions	08
Chapter 1: Getting started with your machine	
• Installing your machine & safety guidelines	14
• Before you start	16
Chapter 2: Working your machine	
• 6 easy steps to do your laundry	17
• Finishing	23
• Wash guide map	26
• Key features	29
Chapter 3: Get more from your machine	
• Tips for best results	32
• Maintenance and cleaning	36
Chapter 4: Useful information	
• Troubleshooting	40
• Display	44
• Technical specifications	47
• Service record	49
• Warranty	53

Warning Electrical safety of this appliance can only be guaranteed when continuity is complete between it and an effective earthing system which complies with local and national safety regulations. It is important that this basic requirement is present and regularly tested. When there is any doubt the onsite wiring system should be inspected by a qualified electrician. IFB cannot be held liable for the consequences of an inadequate earthing system (eg electric shock etc).



Precautions This appliance conforms to safety requirements. Inappropriate use can lead to injury or damage to property. Please read this manual carefully. It contains information on safety, installation, use and maintenance.

Use only less foaming detergents in this machine to avoid inconvenience or damage. It will help you to use your new washing machine optimally and avoid accidents or damage to appliance.

Getting started with your machine

Installing your machine & safety guidelines

1 Select the right spot

Unpack and place the new washing machine in proximity to both water and electrical connections. Ensure that the floor is properly levelled.

2 Removing the transit bolts

- Use a spanner to remove the transit bolts.
- Insert plastic caps provided.
- Keep the transit bolts carefully as they will be required in case you need to shift the machine again.
- Please do not operate the machine until the transit bolts have been removed.

3 Levelling

- Level the machine by using the adjustable screws provided at the bottom for levelling.
- Make sure that the machine rests on all four feet on a level surface.



4 Connection to the water supply

- The water inlet of the machine has a collar with parallel internal threads.
- The water supply point with an external thread/parallel thread should be available within 1 metre of the machine location.
- Do not stretch the water supply hose.

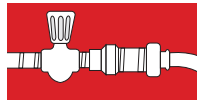

5 Connection to the drain hose

- The machine drains via a drain pump.
- Direct the end of the drain hose into a sink or a basin.
- The drain hose can be placed directly on the floor or can be extended and placed over the sink to a maximum height of 1 metre from the floor.

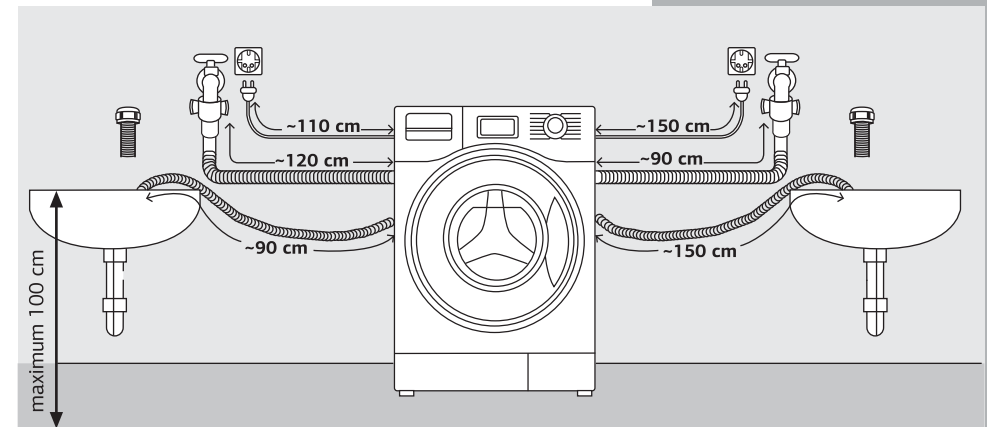
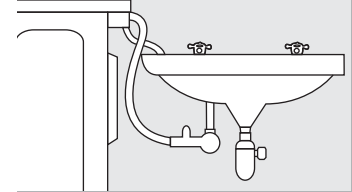

6 Electrical connection

- It is mandatory to have a 16 Amp, 3 pin 220–240 V AC, 50 Hz electrical point with a 16 Amp MCB or automatic short circuit protection device within 1 metre of the machine.
- Make sure your home has proper earthing and there is a firm connection between the plug and the socket. IFB recommends a separate MCB on the socket of the washing machine.
- Proper earthing of the power socket is critical to reliable performance.

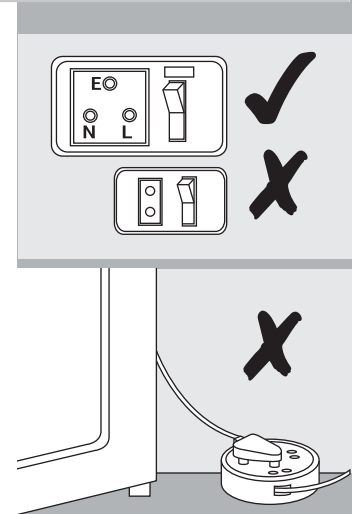

2

Working your machine

Before you start

Check your machine

Ensure that the washing machine has been installed and connected properly.

• Electrical connection

It is mandatory to have a 16 Amp, 3 pin 220–240 V AC, 50 Hz electrical point with a 16 Amp MCB or automatic short circuit protection device.

• Water connection

The water supply point with an external thread 3/4" parallel thread should be available within 1 metre of the machine location. Turn ON the water tap after the connection is secure.

• Drain water hose

Direct the end of the drain hose on to the floor or into a sink or basin up to a maximum height of 1 metre. Hook the hose over the edge of the basin and secure the same.

Your machine was tested before leaving the factory. To remove any water left over from testing procedures, the first wash cycle should be carried out without laundry in the washing machine.

- Turn ON the water tap.
- Pull out the detergent dispenser drawer completely.
- Pour approximately 20 grams of detergent into the detergent dispenser drawer.
- Close the detergent dispenser drawer.
- Set the Program Selector knob to Cotton and set maximum temperature settings.
- Press the Start/Pause button.
- When the End message is displayed turn OFF the Program Selector.

6 easy steps to do your laundry

1 Sort the laundry

- Remove everything from pockets.
- Close zippers, hooks and strings.
- Pre treat collars, cuffs and stains.
- Sort the laundry.
- Check for wash care symbols/labels.

2 Load the laundry

- Check and remove any small articles or any laundry items left inside the drum or on rubber gasket.
- Place garments loosely inside the drum.
- Load garments one by one.
- Close the door and press till you hear a click.

3 Add detergent

- Pull out the detergent dispenser drawer completely.
- Dispense the correct amount of detergent.
- Close the detergent dispenser drawer.
- For heavily soiled clothes use Pre Wash 'I' option and add detergent.
- 'II' to be used for every wash program.
- ☸ to be used to dispense additives. Use the fabric conditioner additives chamber and take care not to exceed the maximum level.
- If liquid detergent is used, please insert the liquid detergent dispenser supplied into the main wash chamber. This ensures that the liquid enters the drum at the right stage of the wash cycle.

***Note** Always use detergents recommended for front load washing machines. Follow the detergent package directions as using too little or excessive detergent is a common cause of laundry problems. Soap flakes or granulated soap powders should not be used in your washing machine. When washing woollens or silk, remember to use the detergent type recommended by the manufacturer.

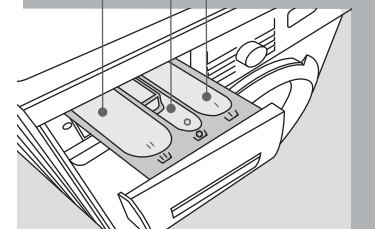
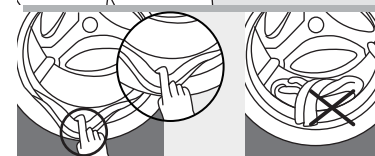
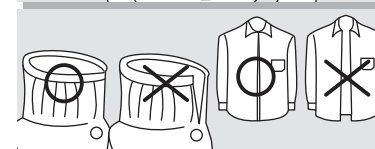

Liquid Detergent Dispenser

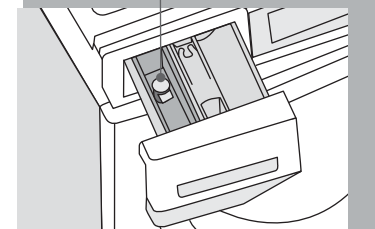

4

Select program

- Switch the washing machine ON.
- Turn the Program Selector knob to the required program position. Start/Pause LED will flash.

PROGRAM	TYPE OF LAUNDRY
I Cotton/Cotton Eco Plus	Cotton colour-fast garments such as shirts, pants, uniforms, as well as bed and table linen, towels, night dresses, pyjamas, underwear etc.
Synthetic	Daily wear garments made of polyester, acrylic or polyamide.
I Mix/Daily	Various types of cotton, synthetic or easy care garments, except special garments such as silk/delicates, dark clothes, wool, duvet, curtains etc.
CradleWash®	Hand wash only garments, as well as delicate washable fabrics made of silk, lingerie, satin, synthetic or sheer fabrics.
Wool	Machine washable wool garments only. A neutral wool wash detergent is recommended.
Express 15'	Lightly soiled coloured laundry made of cotton, linen, synthetic or blended fabrics.
Bulky	Machine washable curtains made of cotton and easy care fabrics. Washes large items such as blankets, bedding covers, sofa covers, pillow covers and bedspreads.
I Baby Wear	Baby clothes, underwear, cloth diapers, pillows, bed sheets etc. A high temperature wash and extra rinses ensure perfect cleaning for sensitive skin.
Anti Allergen	Cotton and linen fabrics in direct contact with skin such as bed linen, pillows, underwear, nappies, towels etc.
I Power	Lightly soiled cotton, synthetic, mixed fabrics items. This program removes stains effectively.
I Refresh	Cotton, synthetic and mixed fabrics items. Use this program to remove odour and de-wrinkle the laundry.

- Choose wash option/additional option.
- To change/cancel the program during machine run, press the power ON/Off button and wait for 2 secs. Then select the new program.

5

Select wash options

Select the different options by touching the desired option button.

Temperature

- You can change the default temperature within a given range.
- Touch the Temperature button on the control panel to change the temperature.
- The temperature selection sequence will be Cold, 20°C, 30°C, 40°C, 60°C, 95°C and repeat.
- Temperature available for selection will flash and the selected temperature will glow on the LED display.
- You can select more wash options or touch the Start/Pause button to start the program.

Spin Speed

- You can change the default Spin Speed within a given range.
- Touch the Spin Speed button on the control panel to change the Spin Speed.
- The Spin Speed selection sequence will be No Spin, 400RPM, 600RPM, 800RPM, 1000RPM, 1200RPM, 1400RPM and repeat.
- The selected Spin Speed RPM will be displayed on the LED display.
- You can select more wash options or touch the Start/Pause button to start the program.

Options

Touch the Options button and Select buttons on the control panel to select the different options. To scroll over the different options available, touch the Options button until the desired option is highlighted. Different options such as Pre Wash, Soak, Extra Rinse, Hot Rinse, Time Saver and Delay Start can be selected by using the Select button. ✓ will appear once the option is selected.





Selection of Options

- During option selection the available option name will flash and the corresponding symbol will be OFF.
- During option selection, the default or already selected option and the corresponding symbol will glow.
- Non-available options and their corresponding symbols will remain OFF.
- Press the Select button to choose the desired options. A corresponding symbol will glow, indicating the option selection.
- After option selection, the option name and its corresponding symbol will glow.



Pre Wash

- If Pre Wash option is selected, the clothes are given a preliminary wash before the main wash.
- Touch the Option and Select buttons on the Control Panel to select the Pre Wash option
- You can select more Wash Options or touch the Start/Pause button to start the program.



Soak

- Soak clothes in soapy water for a calculated amount of time to dislodge dirt from the clothes during the main wash cycle. After this, it automatically continues with the normal cycle.
- During soaking, the clothes will remain stationary for about 15 minutes to 1 hour based on your requirement.
- Touch the Option and Select buttons on the Control Panel to select the Soak option.
- Touch the Select button to select the soak time from 15 minutes, 30 minutes, 1 hour, as desired.
- You can select more Wash Options or touch the Start/Pause button to start the program.
- It is not advisable to soak coloured garments for a long time because they are likely to bleed colour.

Extra Rinse

- An additional rinse cycle is executed to remove any leftover detergent on the clothes to give a better feel to the fabric. A maximum of 3 additional rinses can be selected.
- Touch the Option and Select buttons on the Control Panel to select the Extra Rinse option.
- Touch the Select button to select the number of extra rinses from 1, 2, 3, as desired.
- You can select more Wash Options or touch the Start/Pause button to start the program.

Time Saver

- This option allows you to save time on your washing by decreasing the program time.
- Touch the Option and Select buttons on the Control Panel to select the Time Saver option.
- You can select more Wash Options or touch the Start/Pause button to start the program.

Steam

- Steam is produced inside the drum at the most effective time to enhance the wash.
- Steam option is by default and cannot be deselected for Cotton, Mix/Daily, Baby Wear, Power Steam and Refresh programs.





Delay Start

- Before starting a program, you can specify the time after which the program starts.
- Touch the Delay button on the Control Panel to select the Delay Start time.
- The Delay Start can be chosen from a minimum of 30 minutes to a maximum of 24 hours.
- A program time in steps of 30 minutes up to the first 5 hours, in steps of 1 hour up to 12 hours and in steps of 2 hours up to 24 hours can be selected.
- You can select more wash options or touch the Start/Pause button to start the program.

Child Lock

- You can safeguard your washing machine to prevent any unintentional changes to the selected options and to the program sequence by activating the Child Lock.
- To select the Child Lock, touch the Spin Speed and Options buttons simultaneously for 2 secs.
- The Child Lock symbol will glow on the LED display if the Child Lock has been activated.
- No changes can be made while the program is running.
- If the appliance is switched OFF and then back ON while a program is running, the program will continue from the point at which it was interrupted.
- The door will remain locked at the end of the program.
- You can disable the Child Lock by touching the Spin Speed and Options buttons simultaneously for 2 secs till the Child Lock symbol goes OFF.





6 Start washing

- Touch Start/Pause button to start washing. The Start/Pause LED will glow.
- To interrupt the cycle and change wash option or to add/remove laundry, touch the Start/Pause button once to pause the program.
- Door status will be displayed after touching the Start/Pause button. The door cannot be opened if the water level inside the drum is above the rubber sleeve level and if the water temperature inside the drum is high.





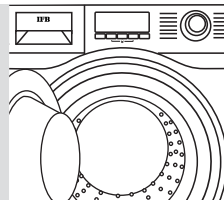













Finishing

Please ensure you take the following steps after the program has ended to ensure the safety of your machine.

- When the program ends, 'End' message will be shown on the display.
- Door can be opened after above message is displayed.
- The machine has been programmed to switch off all visual displays such as LEDs to save energy. This is in line with the latest Energy Using Product norms (EUP).

1		2		3	
	Open door and remove laundry.		Turn the machine OFF and leave the door slightly open. Switch OFF the input power supply to the washing machine.		Turn OFF tap.

Washing symbols—a guide

	Resistant material
	Delicate fabric
	Washable at 95°C
	Washable at 60°C
	Washable at 40°C
	Washable at 30°C
	Hand wash
	Dry clean only
	Wool seal
	Bleachable in cold water
	Do not bleach
	Do not dry clean
	Dry flat
	Hang to dry
	Dry on clothes hanger
	Tumble dry, normal heat
	Tumble dry, reduced heat
	Do not tumble dry



We two look great like this

Fits perfectly into your home

No germs, only goodness with IFB washing machines and dryers

IFB Combo Unique Features*



ANTICREASE



PREVENTS FADING OF CLOTHES



GERM-FREE SOFT CLOTHES



WALL MOUNTABLE TO SAVE SPACE



*Combo features vary with product models

Wash guide map

Program	Options									
	Pre Wash	Soak	Extra Rinse	Rinse Hold	Time Saver	Steam	Delay Start	Spin Speed RPM	Temperature°C	Laundry Weight Kg
I Cotton	✓	✓	✓	✓	✓	*	✓	400-1400/No Final Spin	Cold, 20, 30, 40, 60, 95	8.0
Cotton Eco Plus	✗	✓	✓	✓	✗	✗	✓	400-1400/No Final Spin	40,60**	8.0
Synthetic	✓	✓	✓	✓	✓	✗	✓	400-800/No Final Spin	Cold, 20, 30, 40,60	3.5
Anti Allergen	✗	✓	●	✓	✓	✗	✓	400-1000/No Final Spin	40,60	3.0
I Baby Wear	✗	✓	✓	✓	✓	*	✓	400-800/No Final Spin	Cold, 40, 60	3.0
Rinse/Spin Dry	✗	✗	✓	✓	✓	✗	✓	400-1400/No Final Spin	✗	8.0
Tub Clean	✗	✗	✗	✗	✗	✗	✗	✗	Cold, 60, 95	✗
Wool	✗	✗	✓	✓	✗	✗	✓	400-800/No Final Spin	Cold, 30, 40	2.0
Express 15'	✗	✗	✓	✓	●	✗	✓	400-800/No Final Spin	Cold, 30, 40	2.0
I Power Steam	✗	✗	✓	✓	✗	*	✓	400-800	✗	3.0
I Mix/Daily	✗	✗	✓	✓	✓	*	✓	400-1000/No Final Spin	Cold, 20, 30, 40	3.5
CradleWash®	✗	✗	✓	✓	✗	✗	✓	400-600/No Final Spin	Cold, 30, 40	2.0
Bulky	✓	✓	✓	✓	✓	✗	✓	400-800/No Final Spin	Cold, 40, 60	2.0
I Refresh	✗	✗	✗	✗	✓	*	✗	✗	✗	1.0 (1-3 items)

• By default and can be deselected.

* By default and cannot be deselected.

- ✓ Option available and can be selected.
- ✗ Option not available and cannot be selected.

**Program setting for BEE test in conformity with IEC 60456 with maximum Spin Speed selection settings.

Note With Cotton Eco 60** program, the actual wash temperature attained will be lower than 60 °C, although the wash performance will be at par with the Cotton 60 °C program.

- Depending on water pressure, water hardness, water inlet temperature, quantity and type of textile, detergent used, foam detection, unbalance detection, degree of soiling, ambient condition, selected additional function and power supply fluctuations, the actual values given in the User Manual or with the machine can deviate from the declared standard values as they are tested according to laboratory conditions.
- Program time can also skip or extend due to above mentioned conditions.
- Last run program is selected by default.
- Machine detects the weight of the laundry during program run and automatically adjusts the Time/Rinse Water. Press and hold Option button once during program run to check the total number of wash cycles completed by your washing machine.

Note The design and specifications are subject to change without prior notice due to continuous improvement and product development.

Key features

ADVANCED WASH TECHNOLOGY

4D Wash

Jets of water and shower from paddles ensure complete soaking of clothes. Water mixed with detergent gets injected into your clothes with a spraying mechanism for the best wash.



Aqua Energie

Energises water to get the best out of detergents and takes it deep inside the fabric to dislodge the dirt.

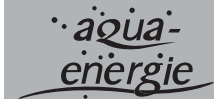

Crescent Moon Drum

Smooth crescent moon grooves on the drum surface create a gentle water cushion that prevents damage to fabrics.



INTELLIGENT WASH PROGRAMS AND OPTIONS

More than 100 specific, thoughtfully designed programs and options give your clothes a magical experience that is tough on stains and gentle on clothes.

Time, Energy and Water Saving

Cotton Eco Plus, Express 15', Time Saver

Fabric friendly

Cotton, Synthetic, Mix/Daily, CradleWash[®], Wool

Hygiene

Anti Allergen, Baby Wear, Tub Clean

Customised for Convenience

Bulky, Rinse/Spin Dry

User friendly Options

Pre Wash, Soak, Temperature, Extra Rinse
Rinse Hold, Spin Speed, Delay Start

WASHING MACHINE CARE

High-Low Voltage Protection

A smart microcontroller continuously monitors the online voltage fluctuations and temporarily stops the program to protect the machine in case the voltage drops below 150 ± 10 V or rises above 270 ± 10 V. The program will resume once the voltage is within safe operating range.

Program Memory Backup

The program resumes from where it left off in case of power failure. No repetition of cycles saves time, water, power and adds longevity to the machine.



USER CONVENIENCE

Auto Imbalance System

This system automatically determines the unbalanced clothes in the machines and redistributes the clothes, making the machine extremely stable in the spin cycle.

Child Lock

Prevents children from tampering with machine settings.

Laundry Add

Lets you add laundry even after the wash cycle has started.

Anti Crease

Reduces wrinkling of clothes after the final spin making them easy to iron.

Auto Foam Control System

Extra foam generated in the machine is detected by special sensing and is controlled.

Tub Clean

Eliminates any impurities, scaling, bacteria and unpleasant smells from the washing machine.

CradleWash[®]

India's first wash program for delicate fabrics provides gentle care that uses a soft to-and-fro, rocking movement.

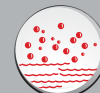

Tips for best results

Before washing

- Empty all pockets.
- Remove metal parts.
- Close any zips and fasten hooks etc before washing.
- Do not wash anything in the machine that is specified as non-machine washable on the wash care label.

While sorting

- Separate polyester fabrics from cotton fabrics.
- Try to have a mix of large and small clothes in each wash load.
- Dark clothes should be washed separately and not with whites.

While loading

- Load large items first, preferably half the wash load.
- Do not wash single items—add one or two similar items.
- Place small items like infants' socks, nylon stockings, handkerchiefs etc in a laundry bag, pillow case or something similar as they may get caught around the door. This will also save your laundry from getting lost.

Water softening

- In case of hard water, use water softening agents or adjust detergent dosage as recommended by the detergent manufacturer.

Easy tips to remove stains

- Ensure you use warm water for soaking or prewashing stained laundry.
- Fresh stains are easier to remove.
- Knowing what kind of stain it is, how old it is, what kind of fabric it is and whether the fabric is colour-fast (check the care label) always helps treat a stain better.
- Always start with cold or warm water as hot water can set in stains. Washing and drying can sometimes set in stains.
- When bleach is recommended, always use a fabric safe one.
- Put the stained area face down on a paper towel or white cloth. Apply the stain remover to the back of the stain. This forces the stain off the fabric instead of through it.

STAIN	TREATMENT
Chewing gum, Adhesive tape, Rubber, Cement	Use ice in a plastic bag to harden the gum. Scrape off what you can and then sponge with white spirits.
Blood	Rinse immediately in COLD water. If stain remains, soak in COLD water with an enzyme Pre Wash.
Chocolate, Cocoa	Sponge with COLD water and soak in an enzyme Pre Wash. If stain persists, rub a little detergent and rinse in COLD water.
Coffee	Blot up quickly and rinse out in COLD water. Rub in a little detergent and wash in the maximum temperature allowed for the fabric type.
Cream, Milk, Ice-cream	Rinse in COLD water and wash normally. If stain is still apparent, sponge with white spirits.

STAIN	TREATMENT
Deodorant areas	Rub affected area with white vinegar and then rinse out in COLD water. Sponge with white spirits. Treat stiffened with enzyme Pre Wash.
Egg	Soak in a COLD enzyme Pre Wash, rinse and wash normally.
Fabric softener	Rub affected areas with bar soap and wash normally.
Fruit	Treat as soon as possible by sponging with COLD water. Rub a little detergent on the stain and wash normally.
Grass	Sponge with white spirits. Rub in an enzyme Pre Wash and wash normally.
Grease, Oil	Lay the affected area face down on an absorbent cloth and work from the back. Sponge with white spirits or dry cleaning fluid. Wash normally.
Iron, Rust	Apply lemon juice and salt and place in the sun. Wash normally.
Collars, Cuffs, Cosmetics	Pre-treat with Pre Wash stain remover or rub with bar soap.
Mildew	Wash in WARM water and detergent. Moisten area with lemon juice, dry in the sun and wash normally. If stain persists and fabric allows, use a bleach.
Mud	Brush off dry mud and rinse in COLD water. If stain persists rub in a little detergent and wash normally.

STAIN	TREATMENT
Paint—oil based	Scrape off any fresh paint and sponge with a non-flammable dry cleaning fluid and wash normally.
Paint—water based	Treat while still wet. Rinse in WARM water and wash normally.
Scorch marks affected	Dampen a cloth with hydrogen peroxide, lay it over the area and press with a fairly hot iron.
Ink	Some inks may be impossible to remove and washing may even set it in. Use Pre Wash stain remover, denatured alcohol or non-flammable dry cleaning fluid.
Nail polish	May be impossible to remove in some cases. Place stain face down on paper towels. Apply nail polish remover to the back of stain. Repeat, placing paper towels frequently. Do not use acetate fabrics.
Shoe polish	Liquid: Pre-treat with a paste of granular detergent and water. Paste: Scrape residue from fabric. Pre-treat with Pre Wash stain remover or non-flammable dry cleaning fluid. Apply detergent into dampened area and wash using bleach safe for fabric.
Candle wax, Crayon	Scrape off surface wax. Place stain face down between paper towels. Press with warm iron until wax is absorbed. Replace paper towels frequently. Treat remaining stain with Pre Wash stain remover or non-flammable dry cleaning fluid. Hand wash to remove solvent and wash using bleach safe for fabric.

Maintenance and cleaning of your washing machine

Cleaning the detergent dispenser drawer

- Remove detergent residues regularly.
- Pull out the detergent dispenser drawer.
- Clean the detergent dispenser drawer with warm water.
- Clean the siphon. Remove the siphon from the compartment and wash under running warm water.
- Detergent residues can build up in the water jets on top of the detergent dispenser drawer housing.
- Before fixing the detergent dispenser drawer, use a bottle brush to clean them out.

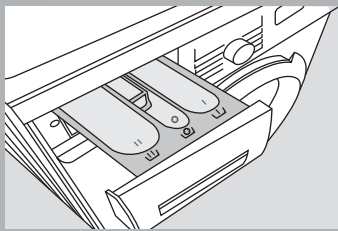

Cleaning the water hose mesh filter

- Turn OFF taps. Disconnect power supply to the machine. Unscrew the inlet hose from the machine and tap. Drain water from the hose.
- Remove the filter mesh from the tap end of the inlet hose and clean under running water with a brush.
- Pull the sieve out of the magnetic valve with a pair of flat nosed pliers. Clean the sieve under running water with a brush. Then fit the sieve back into the valve.

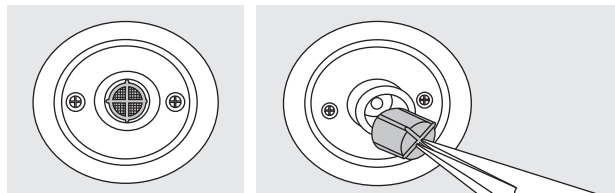
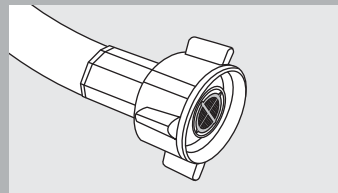
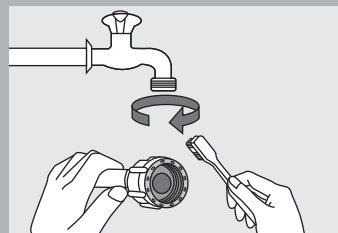

- Screw the inlet hose back to the machine and the tap. Ensure that the sieve and filter are in place. Turn ON the water tap to check if the connection is watertight.

Cleaning the filter

- Filter should be cleaned frequently in order to increase the life of the drain pump.

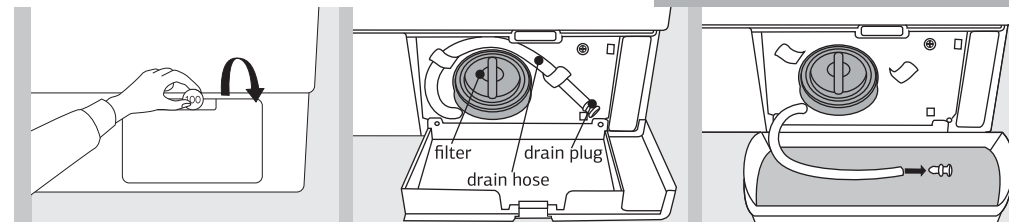

- Open the detachable bottom door by using a coin or key.
- Place a shallow container near the bottom door. Pull out the drain hose and open the drain plug to drain the water from the machine into the container.
- After draining the water through the drain plug, open the filter by rotating it anti-clockwise and remove foreign objects like coins, pins or hooks, if any.

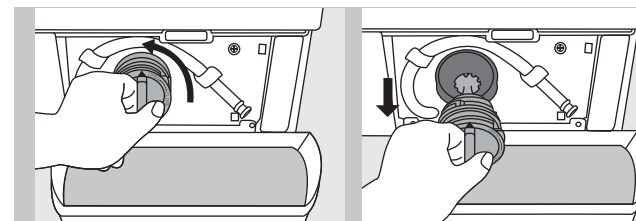

- Tighten the filter and drain plug to their original positions and close the bottom door.
- Do not open the filter during a program run.

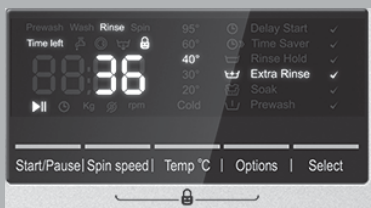

Tub Clean Program

Run this program to eliminate any impurities, scaling, bacteria and unpleasant smell from the washing machine.

Before running the Tub Clean program, empty the washing machine drum; there should not be any clothes in the washing machine during the Tub Clean program. Adding a small amount of powder detergent or descalant (Refer topic Use of descalant) will additionally improve the effect of the Tub Clean program.

To run the Tub Clean program—

IMPORTANT Do not put laundry in the washing machine during Tub Clean.

- Switch ON the washing machine.
- Put powder detergent or descalant in detergent dispenser drawer II.
- With no laundry in the drum, rotate Program Selector to Tub Clean program.
- Press Start/Pause button to start the Tub Clean program.
- END message will be displayed when program finishes.

Note If you do not regularly use washing programs with temperatures over 60°C, it is recommended to run the Tub Clean program at least once per month.

Use of Descalant

- Use Descalant periodically to increase the life of heater and to remove scaling on heater and drum due to hard water.
- Follow the instructions of the descalant manufacturer and make sure that there is no laundry in the washing machine while using it.
- Only use proprietary non-corrosive descaling agents.

Cloth weights

Bottoms

Lungi/Dhoti	200 g
Skirts	200 g
Trousers	250 g
Jeans	400 g

Tops

Cotton shirts	280 g
Other shirts	200 g
Cotton blouses	140 g
Other blouses	100 g
Woollen sweaters	400 g
Heavy sweaters	300 g
Light sweaters	150 g

Other clothes

Cotton saree	650 g
Synthetic saree	350 g
Bath towels	600 g
Hand towels	250 g
Pyjama kurta	400 g
Panties	60 g
Cotton vests	100 g
Underslips	100 g
Long socks, 2 pairs	150 g
Short socks, 2 pairs	85 g
6 handkerchiefs	85 g
12 napkins	1.1 kg

Sheets

Cotton (double)	1 kg
Cotton (single)	500 g
Non cotton (double)	650 g
Non cotton (single)	400 g

Pillow slips

Cotton pillow slips	110 g
Other pillow slips	85 g

Tablecloths

Small	230 g
Large	600 g
Table napkins (4)	150 g

Bedsread

	3 kg
--	------

Blankets

Wool	2 kg
Acrylic	1.5 kg



Let's make washing easier. Here is a list of clothes and their approximate weights to help you figure out a perfect wash load.

Laundry Items	8 Kg
Bath towels	2
Shirts	4
Blouses	3
Skirts	5
Pair of pants	1
Pairs of jeans	3
T-shirts	4
Sets of pyjamas	4
Tea towels	4

DESCAL
Appliance Descaler
brought to you by IFB.
Call IFB Care for details.

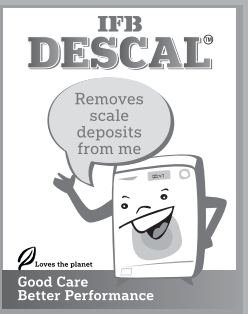

The chart indicates average weights of clothes. The recommended weights of your wash load should not be exceeded to ensure that your washing machine gives your clothes an effective wash. Suggested weights are approximate and may vary.

4 Useful information about your machine

Troubleshooting

When the washing machine does not function properly, check the following points before you contact your service provider.

SYMPTOM LED Display does not glow.

PROBABLE CAUSE

- Power supply is not turned ON.
- Electrical power cord may not be plugged in or connection may be loose.
- Program not selected.

SOLUTION

- Ensure that the supply mains switch is ON.
- Make sure that the plug is plugged in and check for loose connection in plug/socket.
- Ensure that the program is selected.

SYMPTOM Washing machine door does not open.

PROBABLE CAUSE

- Machine is in operation.
- Door open not possible.
- Child Lock is active.

SOLUTION

- Check if the program is active. If yes, pause the program check door symbol indication. For safety reasons, the washing machine door cannot be opened when water level, temperature or speed is too high.
- Check if 'dl Er' message is displayed on the display.
- Disable the Child Lock and wait for 1–2 minutes till Door symbol glows on the display

SYMPTOM Program does not start.

PROBABLE CAUSE

- Machine Start/Pause button not pressed.
- Water supply tap not turned ON/ no water supply/low water pressure
- Door not closed properly.
- Program either in Pause/Soak or Rinse Hold mode.

SOLUTION

- Ensure that the Start/Pause button is touched. Start/Pause LED will glow when touched.
- Open tap fully and ensure that there is water supply with normal water pressure.
- Open and close the door firmly.
- Check the status on the display and refer to the user manual.

SYMPTOM Water does not enter into machine. Detergent not being flushed into the drum.

PROBABLE CAUSE

- Water supply tap not turned ON/ no water supply/low water pressure.
- Door not closed properly.
- Bent inlet hose, sieve or inlet valve/inlet hose clogged.

SOLUTION

- Open the tap fully and ensure that there is water supply with normal water pressure.
- Open and close the door firmly.
- Check if the inlet hose is bent or sieve is blocked.

SYMPTOM Suds escaping from detergent dispenser tray. Excessive foam in drum. Residues of detergent on clothes.

PROBABLE CAUSE

- Detergent used is not a Front Loader detergent.
- Excessive detergent used.
- Overloading of clothes.
- Cold wash program.
- Low water pressure.

SOLUTION

- Use detergent recommended for Front Loader washing machines only.
- Reduce the detergent dosage.
- Do not overload the washer.
- Use hot wash program.
- Start when water pressure is normal.

SYMPTOM Water leakage from machine.

PROBABLE CAUSE

- Inlet hose connection loose.
- Filter not tightened.
- Inlet hose leaking.

SOLUTION

- Check and tighten the inlet hose connection.
- Check and tighten the filter.
- Contact IFB Care.

SYMPTOM Machine does not drain.

PROBABLE CAUSE

- Filter clogged.
- Drain hose end above 1 metre from the floor level.
- Drain hose kinked or clogged.

SOLUTION

- Check and clean the filter.
- Drain hose should be placed between 1 metre to ground level.
- Clean and straighten the drain hose.

Wash only machine washable door mats/bath mats in the washing machine. Washing of non washable mats will cause lint/fibre build up and may lead to clogging of the drain pump.



SYMPTOM Machine does not spin or clothes stay wet.

PROBABLE CAUSE

- Load is too small. Unbalanced load.
- Overloading of clothes.
- Spin Speed is set to ORPM or lower Spin Speed is selected.
- Rinse Hold option selected.
- Filter clogged.
- Excessive/high foaming detergent.

SOLUTION

- Add 1 or 2 similar items to help balance the load. Rearrange load to allow proper spinning.
- Load clothes as per the fabric type and capacity recommended for chosen program.
- Select higher Spin Speed.
- At Rinse Hold stage touch Start/Pause button.
- Check and clean filter.
- Use detergent recommended for Front Loader washing machines only.

SYMPTOM Machine vibrates more during spinning.

PROBABLE CAUSE

- Machine not levelled properly.
- Filter clogged partially.
- Unbalanced load.

SOLUTION

- Check and level the machine.
- Check and clean the filter.
- Add 1 or 2 similar items to help balance the load. Rearrange load to allow proper spinning.

SYMPTOM Motor noise.

- It is normal for noises to be heard while motor is running.

SYMPTOM Pump noise.

- It is normal for noises to be heard from the pump during the start up and final stage of draining. However check for filter clogging.

SYMPTOM Program cycle time delayed. Balance time on display remains unchanged.

- It is normal as the washing machine time may vary depending upon the type and quantity of laundry, inlet water pressure, inlet water temperature, variations in power supply and other usage conditions.
- If there is an unbalanced load then the machine may make several attempts to redistribute the clothes in order to minimise the vibrations resulting in extended program duration.

SYMPTOM Poor soil removal.

PROBABLE CAUSE

- Incorrect detergent dosage.
- Use of cold wash program.
- Load size not as per capacity.
- Stains on clothes.
- Mix of heavily soiled items with lightly soiled items.

SOLUTION

- Use correct amount of detergent for load size and water hardness.
- Use hot wash program.
- Use correct load size.
- Pre-treat stain and any soil according to directions given under 'Easy tips to remove stains'.
- Separate heavily soiled items from lightly soiled ones.

SYMPTOM Blue stains on clothes.

PROBABLE CAUSE

- Excessive fabric additives. Cheaper quality additives.

SOLUTION

- Do not overfill fabric softener and do not pour liquid fabric softener directly onto fabric.

SYMPTOM Black or grey marks on clothes.

PROBABLE CAUSE

- Less quantity detergent/hard water.
- Some clothes with existing stains.

SOLUTION

- Use correct amount of detergent for load size, amount of soil and water hardness.
- Do not mix good clothes with stained clothes.

SYMPTOM Yellow or brown rust stains.

PROBABLE CAUSE

- Dirty incoming water.

SOLUTION

- Before washing run water for a few minutes to clean lines or start the program only when the water is clean.
- To restore a discoloured load of whites use rust remover safe for fabric.

SYMPTOM Residue of detergent.

PROBABLE CAUSE

- Overloading of clothes.
- Excessive use of detergent.
- Cold wash program.

SOLUTION

- Do not overload the washer.
- Use proper amount of detergent.
- Use hot wash program.

SYMPTOM Buttons not working.

PROBABLE CAUSE

- Button not pressed/touched properly.

SOLUTION

- All the buttons are sensitive and need to be gently tapped/touched with the finger.

If the problem persists, contact IFB Care.

Display

The LED Display gives you complete information

- Program selection
- Wash Option selection
- Balance time of the program
- Program status
- Problem/fault indications, if any
- Child Lock selection
- Door status

For any code which is not present in the following list or if the suggested solution does not fix the problem, call IFB Care or an authorised dealer.

DISPLAY MESSAGE

PROBABLE CAUSES

SOLUTION

r ins

HOLD

At the Rinse Hold step this code will toggle.

Touch Start/Pause button or select Spin Speed/Spin Dry program

dLAY

Code will be displayed during Delay Start mode.

door

Door not closed properly.
Door not locked.

Open and then close the door properly.

DISPLAY MESSAGE

PROBABLE CAUSES

SOLUTION

tAP

Water tap turned OFF.

Turn ON the tap.

Water supply not available or low water pressure.

Washing machine will start automatically on resumption of water supply.

Sieve/filter blocked in water inlet hose

Clean the sieve filter (Refer topic Cleaning the water hose mesh filter)

Bent/damaged water inlet hose.

Remove bend/damage.

dLEr

Door not getting unlocked. Switch OFF the washing machine, wait for 2 min and check if the door will open. Do not try to open the door forcibly. If the door cannot open or if the same message is displayed, switch OFF the washing machine and contact IFB Care.

HEAT

Water temp is above 60°C at the start of program

Start New/Drain program once the water cools down to approximately 60°C. Switch OFF the washing machine, wait for 2 secs and restart. If the same message appears again, switch OFF the washing machine and contact IFB Care.

**DISPLAY MESSAGE****PROBABLE CAUSES****SOLUTION**

OFEr

PrS

Switch OFF the washing machine, wait for 2 secs and restart. If the same message is displayed, turn OFF the tap, switch OFF the washing machine and contact IFB Care.

h260

Input voltage is high

Washing machine will start automatically after the voltage decreases to the safe operating level. If this error display persists/occurs frequently, contact your electrician to locate the fault in the electrical system.

L 175

Input voltage is low

Machine will start automatically after the voltage increases to the safe operating level. If this error display persists/occurs frequently, contact your electrician to locate the fault in the electrical system.

Unbl

Laundry load is unbalanced

If the laundry load is small (eg a pair of jeans, 2–3 Turkish towels, a bathrobe etc) it can lead to an unbalanced condition. Add 1–2 similar items to help balance the load and rearrange the load to allow proper spinning.

Technical specifications

Model	Senator WSS 8 Kg 1400RPM
Power Supply	220–240 V Single Phase 50 Hz
Dimensions	62.3 cm (D) x 59.8 cm (W) x 85.8 cm (H)
Net Weight	75 Kg
Capacity	8.0 Kg of dry cotton
Wash Care Program	14 (>100 with Options)
Selector Buttons	Option, Select, Spin Speed Temperature, Start/Pause, Power ON
Selector Knob	Program Selector
Spin Speed	400–1400RPM or Spin Cancel
Water Consumption*	≤ 9 Ltr/Kg/Cycle
Water Pressure	0.3 Bar–10 Bar (30 kPa–1000 kPa)
Power Consumption Max	2150 W
Drain Pump Rating	30 W
Heater Rating	2000 W
Drum	Stainless Steel

* Program setting for BEE test in conformity with IEC 60456

Businesswoman
in the morning

Blogger by evening

Indulge in your passion.
Do more with your time.
Set Yourself Free with IFB.

Installation report

Model _____ Serial no _____

Customer's name _____

Phone (residence) _____ (office) _____

Address _____

Installation check points

Machine delivered on _____

Machine installed on _____

Service engineer to tick appropriately

- Any major transit damage to the machine observed? yes no
- Supply voltage at the time of installation? Volt
- Earthing available? yes no
- Plug point (16 Amp 220–240 V with MCB or other automatic short circuit protection devices) available? yes no
- If MCB is not available, has the customer been advised to correct the same? yes no
- Advised to turn OFF machine after use? yes no
- Is the input water pressure as per machine requirement? yes no
- What is the input water pressure at the water point? Bar
- Machine levelling procedure and importance explained? yes no
- Rat protection mesh installed? yes no
- Detergent and bleach recommendation, relevant Detergent Dispenser Tray chambers explained? yes no
- Safety instructions explained? yes no
- Explained all features of the washing machine to the customer? yes no
- Display function explained (if applicable)? yes no

Service engineer to tick appropriately

• Explained procedure for cleaning coin trap/rubber sleeve/inlet hose filter?	yes <input type="checkbox"/>	no <input type="checkbox"/>
• Explained common error codes (if applicable)?	yes <input type="checkbox"/>	no <input type="checkbox"/>
• Explained unbalance error in Spin mode?	yes <input type="checkbox"/>	no <input type="checkbox"/>
• Explained Program Selection, program and button options (or knobs), indicator lamp/status LED/LCD function, buzzer function (if applicable)?	yes <input type="checkbox"/>	no <input type="checkbox"/>
• Explained troubleshooting?	yes <input type="checkbox"/>	no <input type="checkbox"/>
• Checked following for proper order?		
- Inlet hose	yes <input type="checkbox"/>	no <input type="checkbox"/>
- Detergent Dispenser Tray	yes <input type="checkbox"/>	no <input type="checkbox"/>
- Drain hose	yes <input type="checkbox"/>	no <input type="checkbox"/>
• Informed user of the need to keep drain hose straight and maximum height of draining?	yes <input type="checkbox"/>	no <input type="checkbox"/>
• Machine installed on trolley?	yes <input type="checkbox"/>	no <input type="checkbox"/>
• Genuine IFB trolley?	yes <input type="checkbox"/>	no <input type="checkbox"/>
• Warranty terms explained?	yes <input type="checkbox"/>	no <input type="checkbox"/>

Note: MCBs and proper earthing are critical to the safety of the appliance. Operating the appliance without them is not advisable and may be injurious and fatal.

Installed by (Engineer) _____ Signature _____

Customer's response

- The installation person was courteous and helpful Yes No
- I would describe my experience with the process of installation as
 Unacceptable Non-satisfactory Satisfactory Very satisfactory

I certify that the above information and checks have been done to my satisfaction and I am fully satisfied with the installation of the washing machine. The above points have been explained and I have done the installation as per above.

_____ **Customer's Signature** _____ **Date** _____ **Time**

Warranty—Customer copy

Model _____

Serial no _____

Dealer's name _____

Date of purchase _____

Customer's name _____

Address _____

Phone _____

Email _____

Motor serial no _____

OVER **6 MILLION** SATISFIED CUSTOMERS



UF421PKMAN632	A
---------------	---

Shop 24x7 @ www.ifbappliances.com | Email customerservice@ifbglobal.com | Call 1860 2085678 or 1860 4255678)

www.facebook.com/IFBappliances twitter.com/IFBAppliances www.instagram.com/ifbappliances/

www.youtube.com/channel/UCJTIHxPTfez4mrbVBIQLb9Q

wysiwg.co.in | September 2020

